

Corrigé activité les 7 récipients

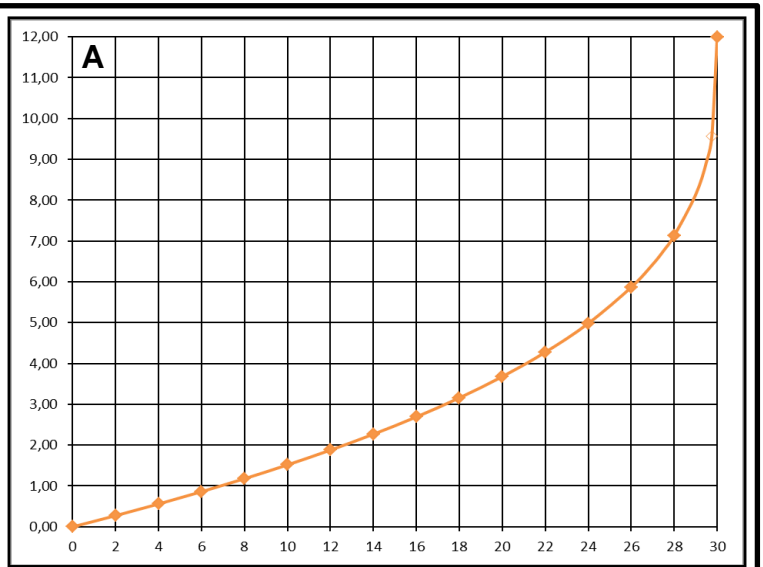

I

t	0	2	4	6	8	10	12	14	16	18	20	22	24	26	28	30
h	0,00	0,27	0,56	0,86	1,18	1,52	1,88	2,27	2,69	3,16	3,68	4,28	4,98	5,87	7,13	12,00

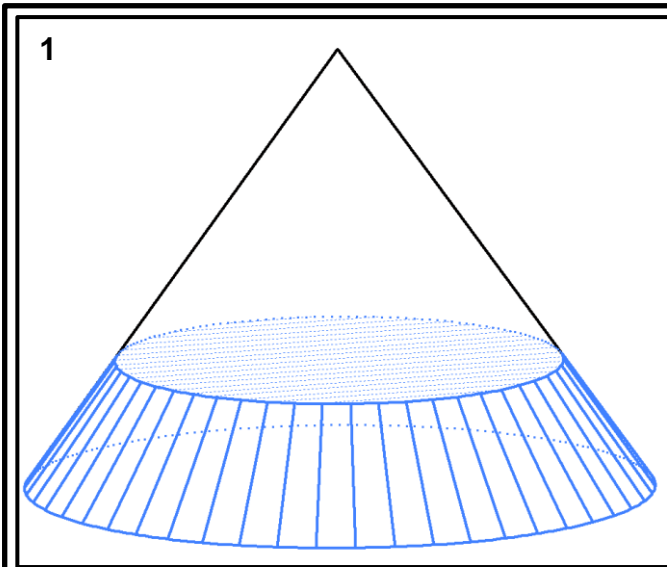
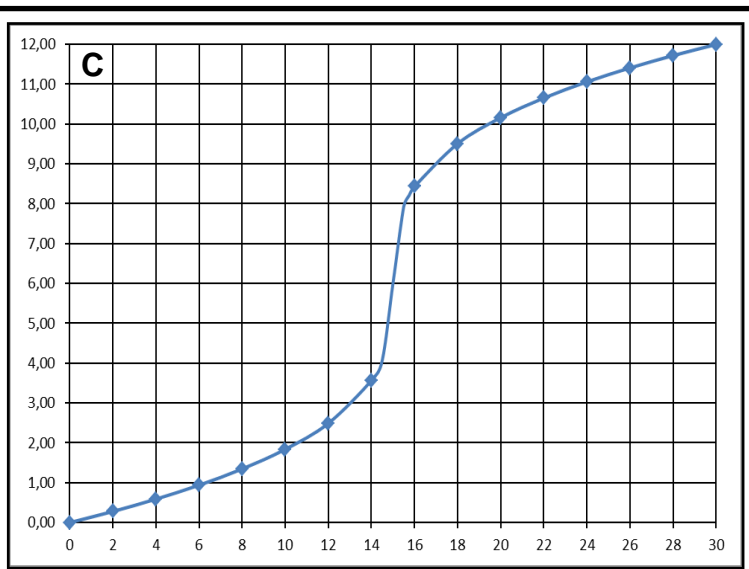
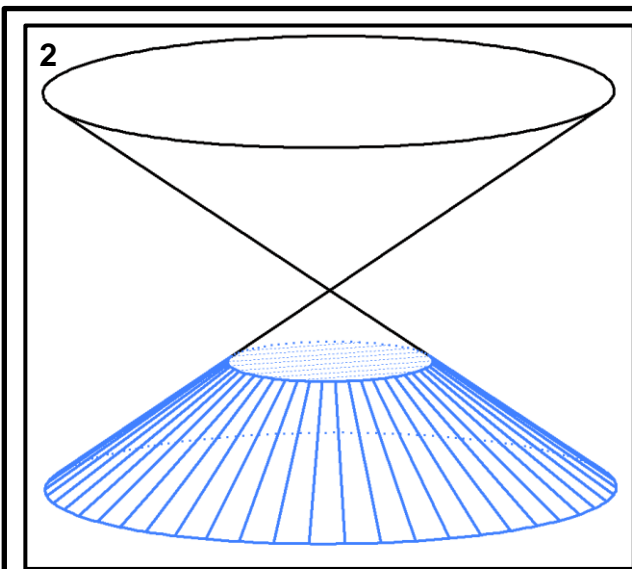

VI

t	0	2	4	6	8	10	12	14	16	18	20	22	24	26	28	30
h	0,00	0,28	0,59	0,94	1,35	1,84	2,49	3,57	8,43	9,51	10,16	10,65	11,06	11,41	11,72	12,00

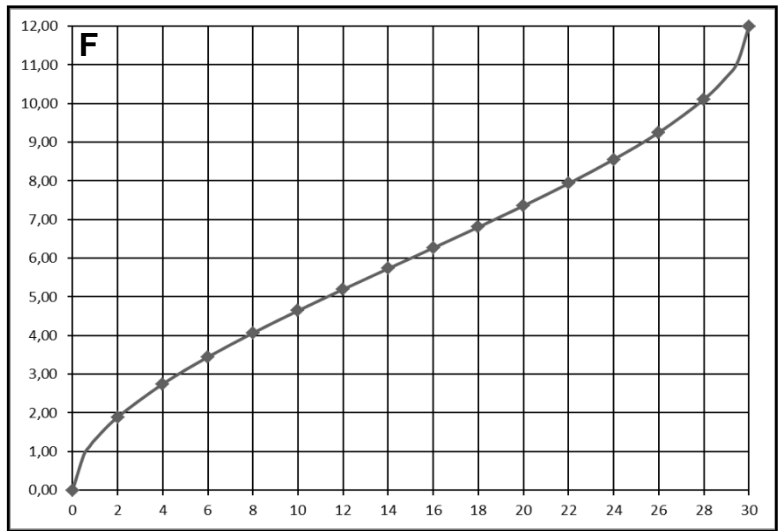
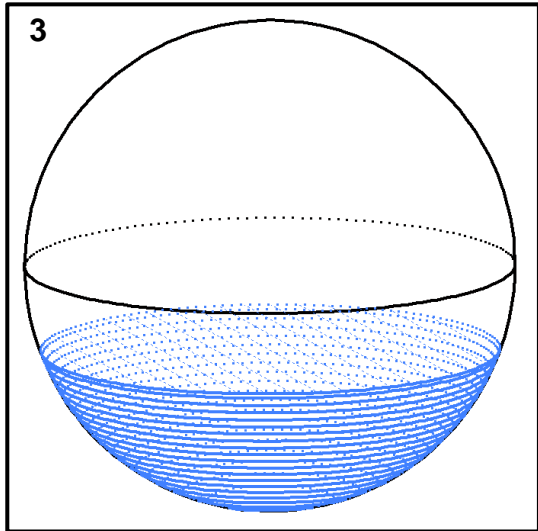

V

t	0	2	4	6	8	10	12	14	16	18	20	22	24	26	28	30
h	0,00	1,89	2,75	3,45	4,07	4,64	5,20	5,73	6,27	6,80	7,36	7,93	8,55	9,25	10,11	12,00

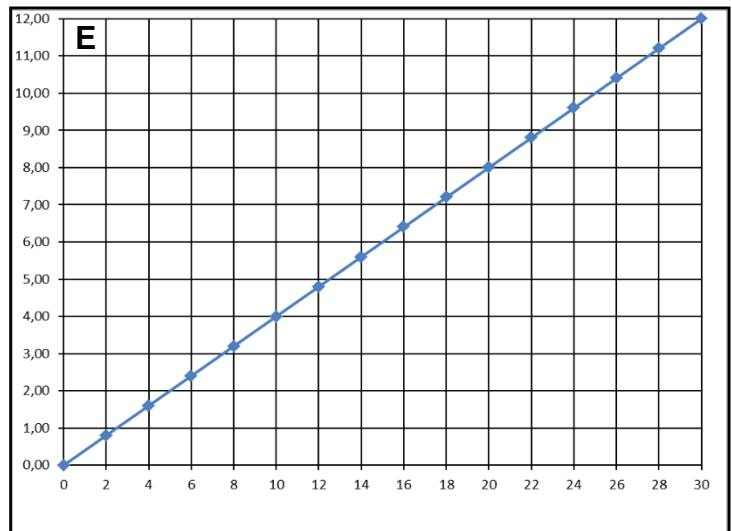
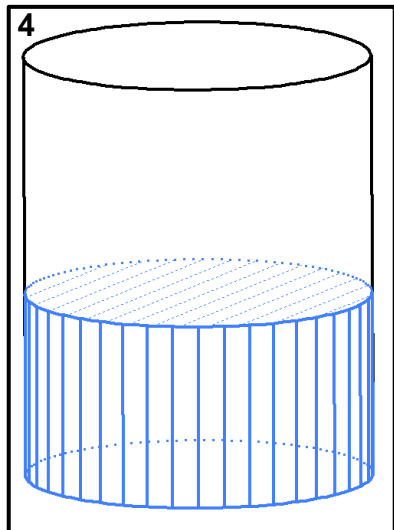

IV

t	0	2	4	6	8	10	12	14	16	18	20	22	24	26	28	30
h	0,00	0,80	1,60	2,40	3,20	4,00	4,80	5,60	6,40	7,20	8,00	8,80	9,60	10,40	11,20	12,00

5

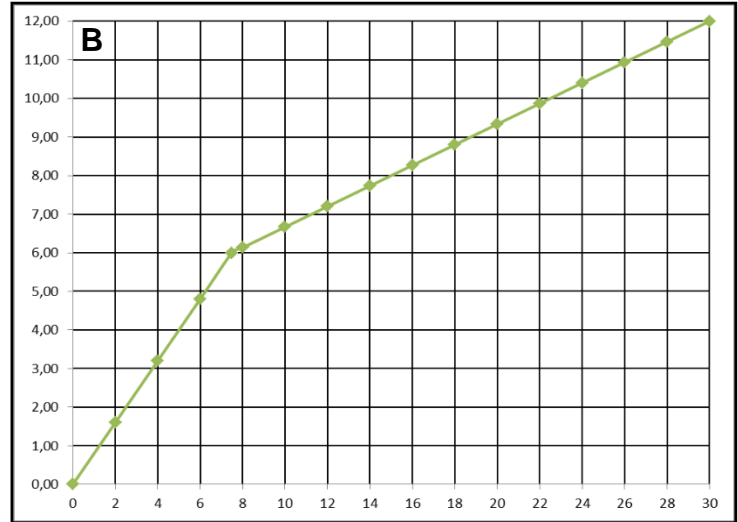
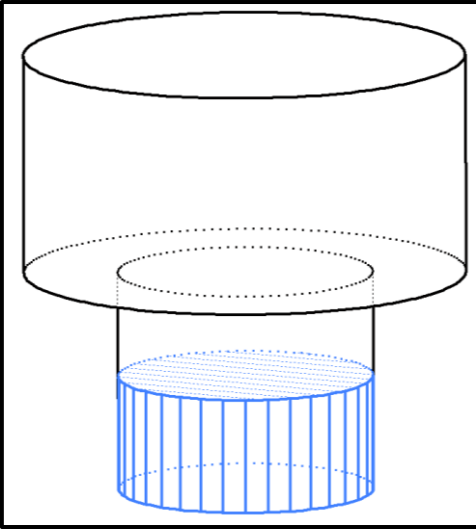

II

t	0	2	4	6	8	10	12	14	16	18	20	22	24	26	28	30
h	0,00	1,60	3,20	4,80	6,13	6,67	7,20	7,73	8,27	8,80	9,33	9,87	10,40	10,93	11,47	12,00

6

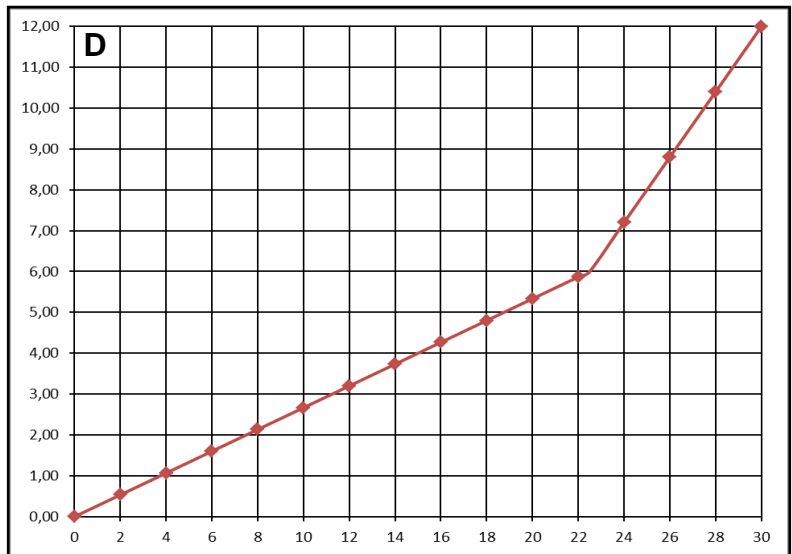
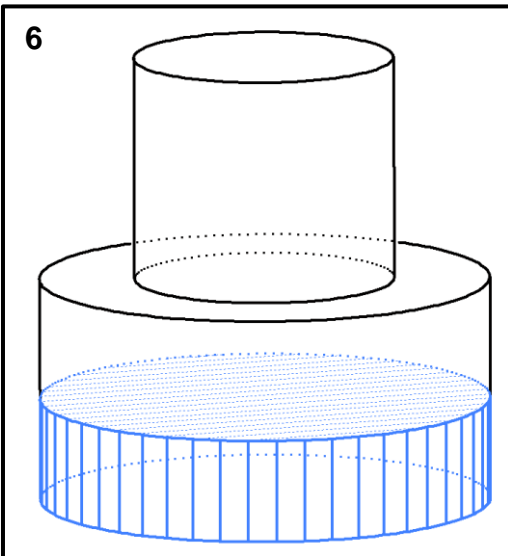

III

t	0	2	4	6	8	10	12	14	16	18	20	22	24	26	28	30
h	0,00	0,53	1,07	1,60	2,13	2,67	3,20	3,73	4,27	4,80	5,33	5,87	7,20	8,80	10,40	12,00

7

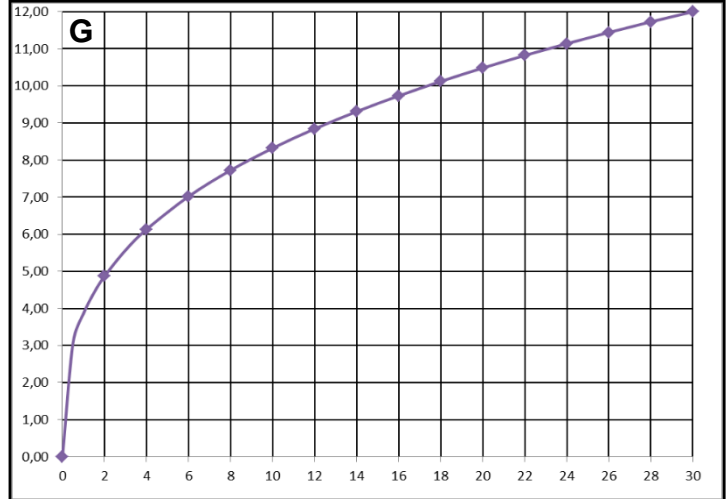
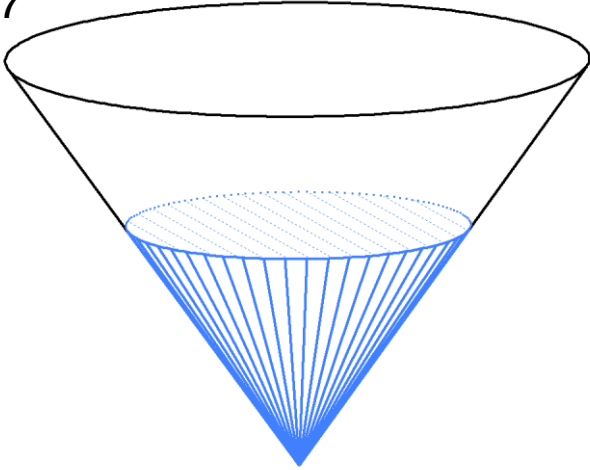

VII

t	0	2	4	6	8	10	12	14	16	18	20	22	24	26	28	30
h	0,00	4,87	6,13	7,02	7,72	8,32	8,84	9,31	9,73	10,12	10,48	10,82	11,14	11,44	11,73	12,00